

Ändrings Nr	Ändringens art / Ändringsmeddelande	Godkänd av	Datum
1			2014-01-29

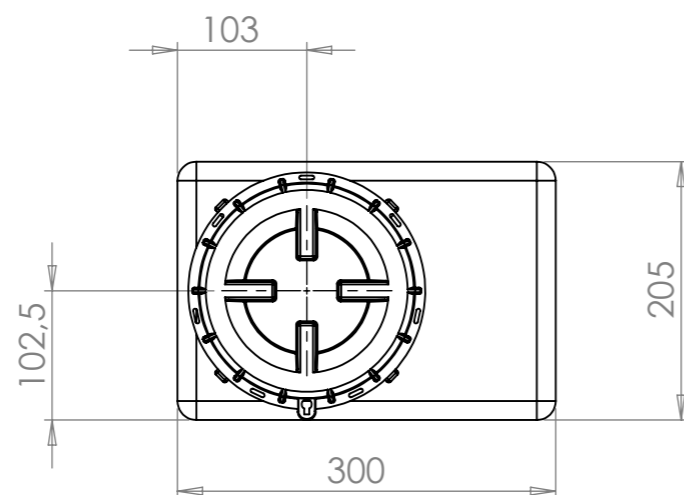
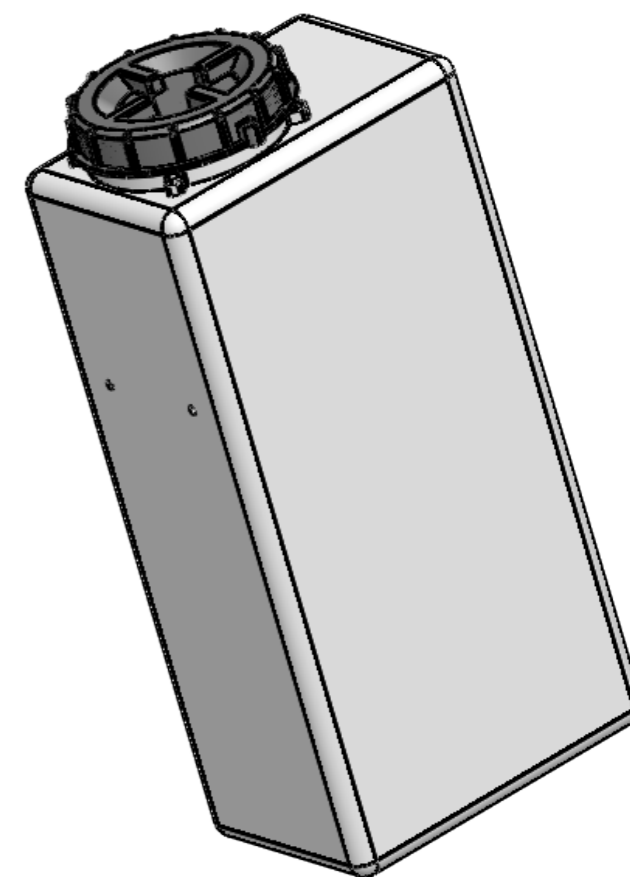
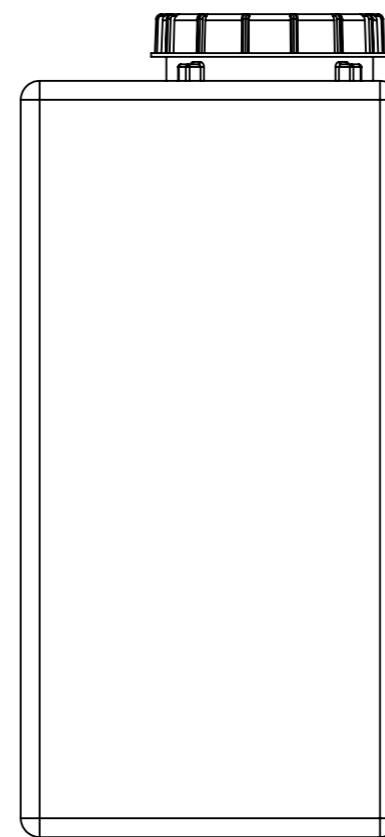
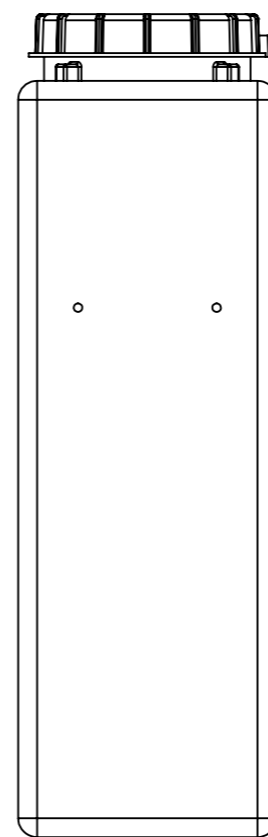
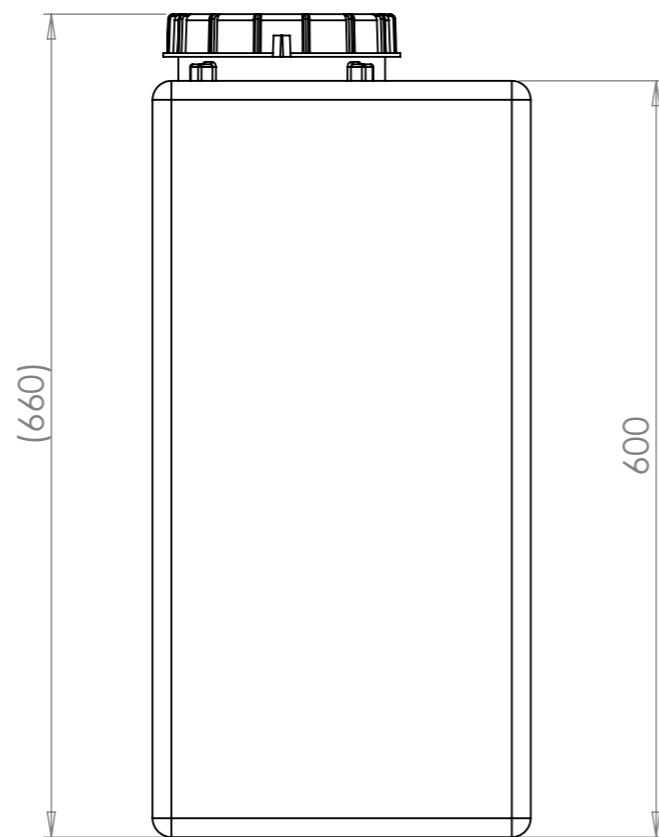
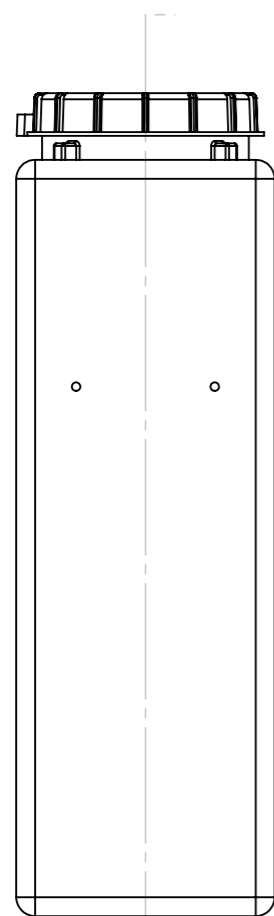
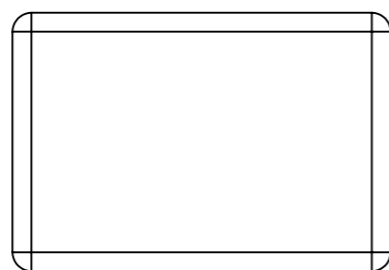

This drawing and design is the property of Cipax. Copying and distribution of the drawing or any contents is prohibited without written permission from authorised personal at Cipax

Generella toleranser om ej annat anges på ritning	Tillåtna avvikelser för längdbasmåttområde				
General tolerances if not other stated on drawing	Permissible deviations for basic length size range				
	0-20	>20-75	>75-150	>150-300	>300
	± 0,5 mm	± 1 mm	± 1,5 mm	± 1,3 %	± 1 %

Konstruerad av JA	Granskad av SE	Godkänd av - datum JA- 2013-01-22	Generell tolerans SS-ISO 2768-1	Generell Ytjämnhet, Ra	Vyplacering 	Skala 1:6
Ägare 			Titel/Benämning		Blad 1(1)	
Ritningsnummer 20035			Utgåva			